

Article number: 208060111

Description: E+G Sphericalwasher female DIN 6319-12-D-NI  
Stainless Steel 1.4305

## Measures

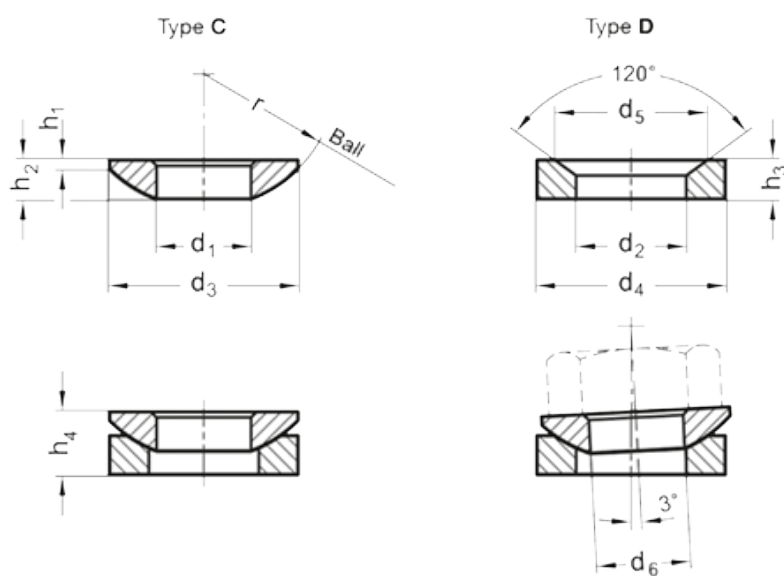

$d_2 = 12.0$

$d_4 = 21$

$d_5 = 18.5$

$d_6 = M10$

$H_3 = 4.2$

$H_4 = 6.5$